

SEWING MACHINE TABLE
COMFORT 1 (C 1L , C 1XL)
СТОЛ ДЛЯ ШВЕЙНОЙ МАШИНЫ



SYMBOLS



ATTENTION

ВНИМАНИЕ



ASSEMBLY & ADJUSTMENT

СБОРКА РЕГУЛИРОВКА



OPERATION

ЭКСПЛУАТАЦИЯ



STORAGE

ХРАНЕНИЕ

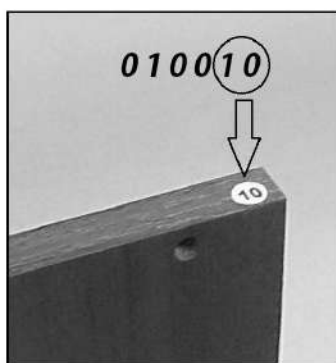

INDICATING MARK

ОБОЗНАЧЕНИЕ



SPECIAL OPERATION

СПЕЦИАЛЬНЫЕ ОПЕРАЦИИ

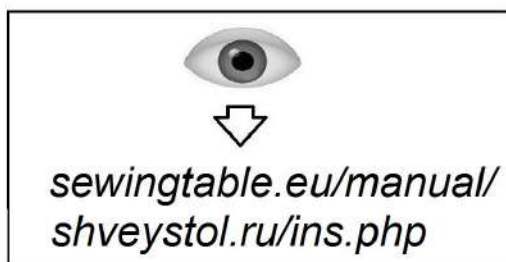

WATCH

СМОТРЕТЬ

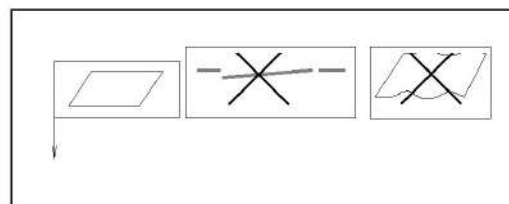





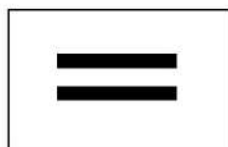



















EVEN SURFACE

РОВНАЯ ПОВЕРХНОСТЬ



EQUALITY

РАВЕНСТВО

010001 1x		010002 1x		010003 1x		010004 1x		
010006 1x		010007 1x		010008 1x		010009 1x		
 <p>020001 2x</p>		 <p>020002 2x</p>		 <p>020003 1x</p>		 <p>020004 1x 020005 1x</p>		
 <p>020006 1x</p>		 <p>020008 1x</p>		 <p>020010 L 660 1x</p>		 <p>020011 1x</p>		 <p>020012 1x</p>
<p>030001 3 * 16 24x</p> 	<p>030002 3,5 * 16 8x</p> 	<p>030003 6,2 * 50 8x</p> 	<p>030004 φ5 * 30 4x</p> 	<p>030005 4,2 * 16 10x</p> 	<p>030006 2,9 * 13 4x</p> 			
<p>030007 φ6 2x</p> 	<p>030008 φ4 2x</p> 	<p>030009 M4 * 20 2x</p> 	<p>030010 φ6 4x</p> 	<p>030011 φ15 8x</p> 	<p>030012 φ18 6x</p> 			
<p>030013 L = 35 6x</p> 		<p>030015 φ8 * 30 6x</p> 		<p>030014 φ15 h12 6x</p> 	<p>030033 4,2 * 13 15x</p> 			

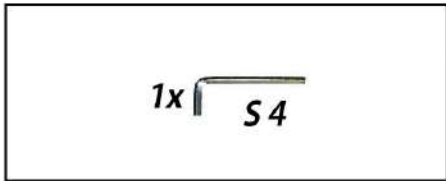
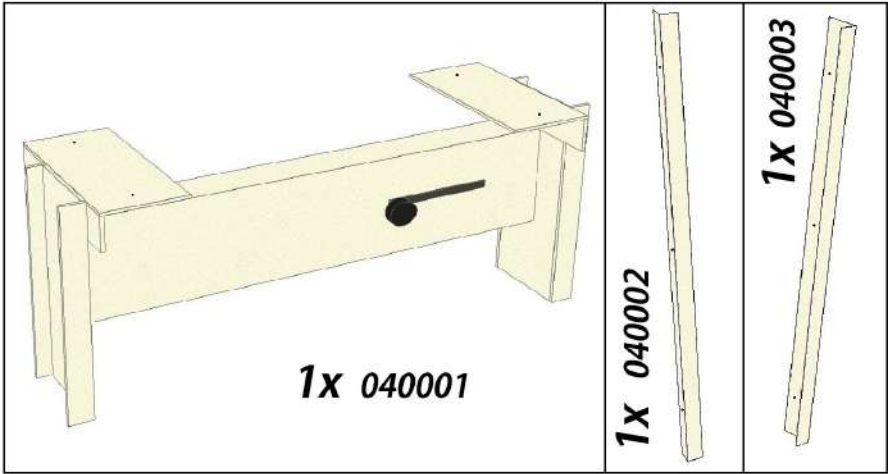

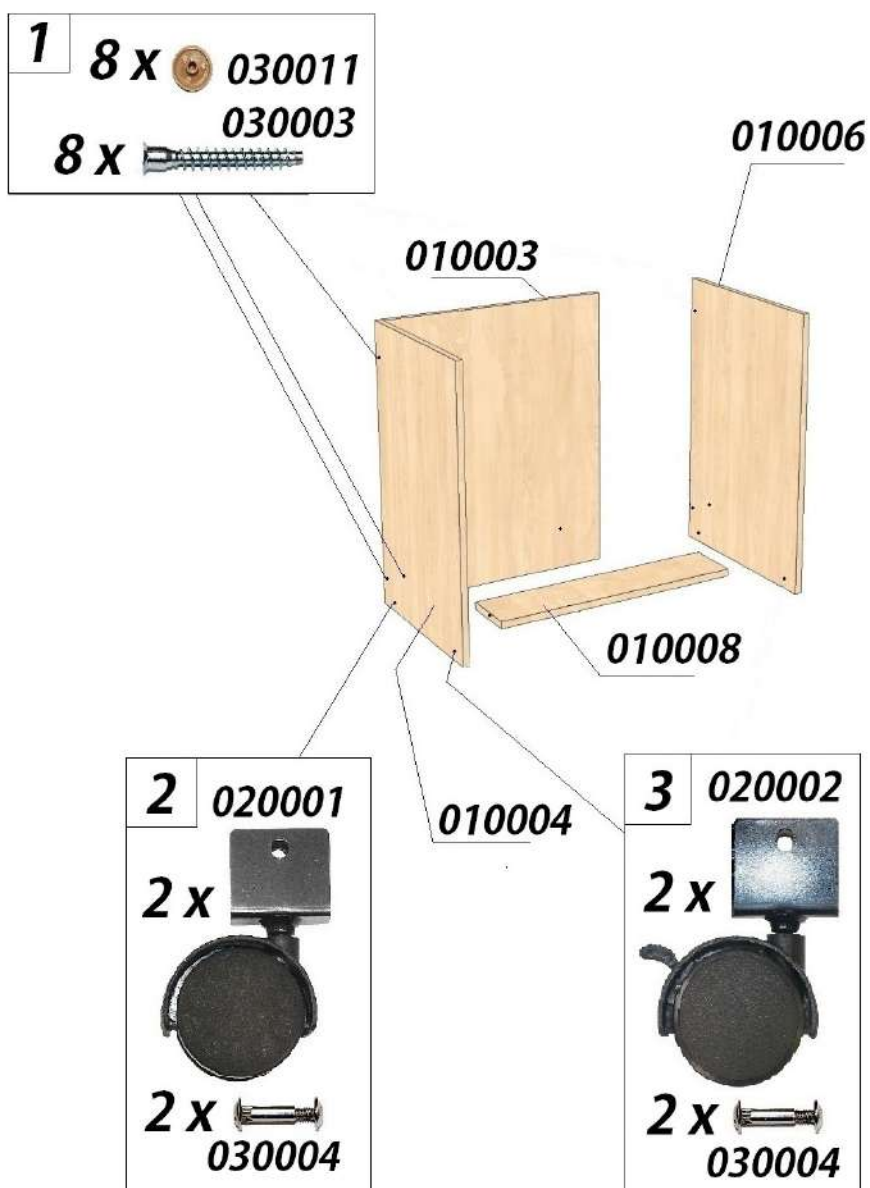

* Входит в комплект стола.
Included into table set.

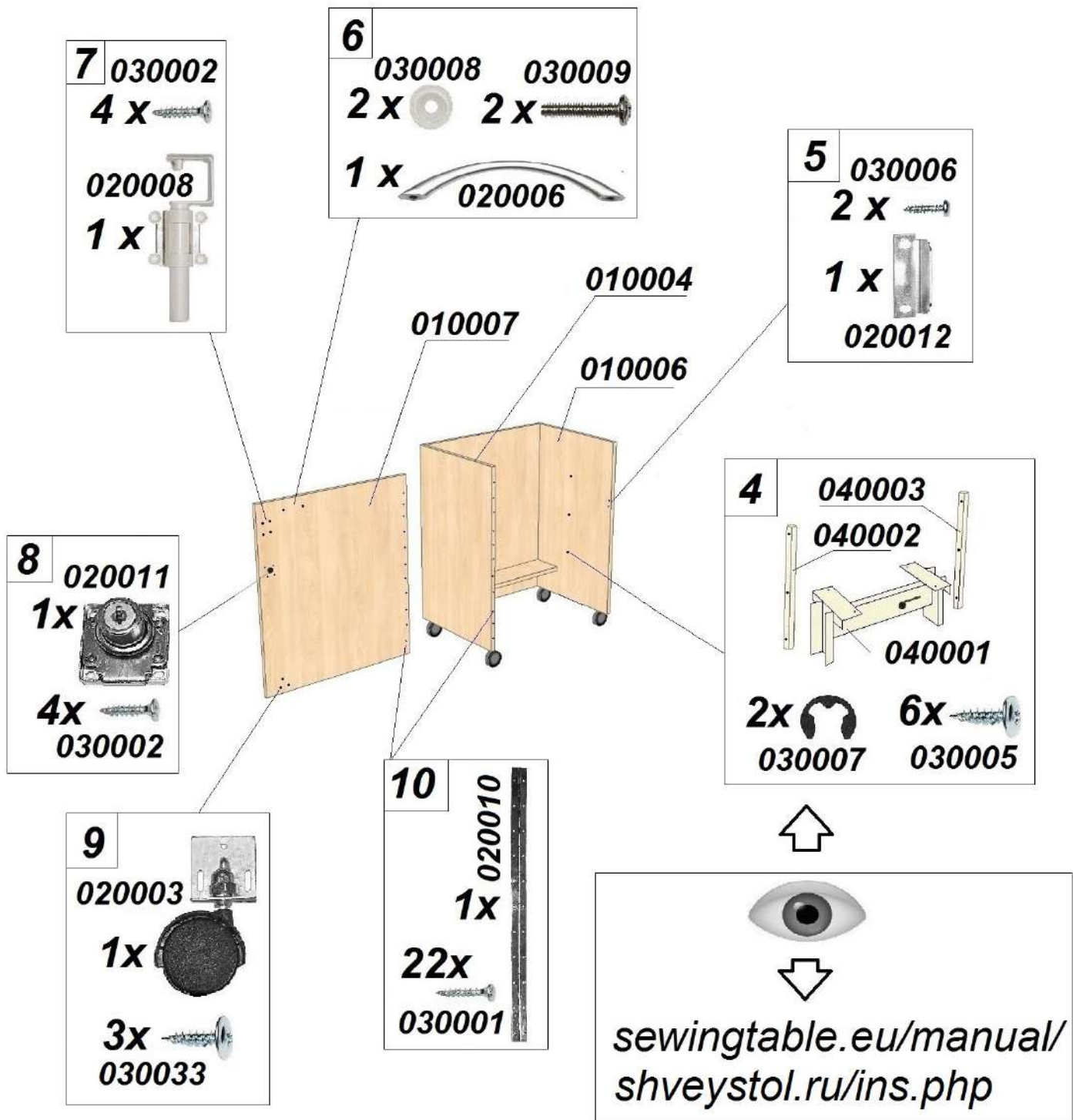

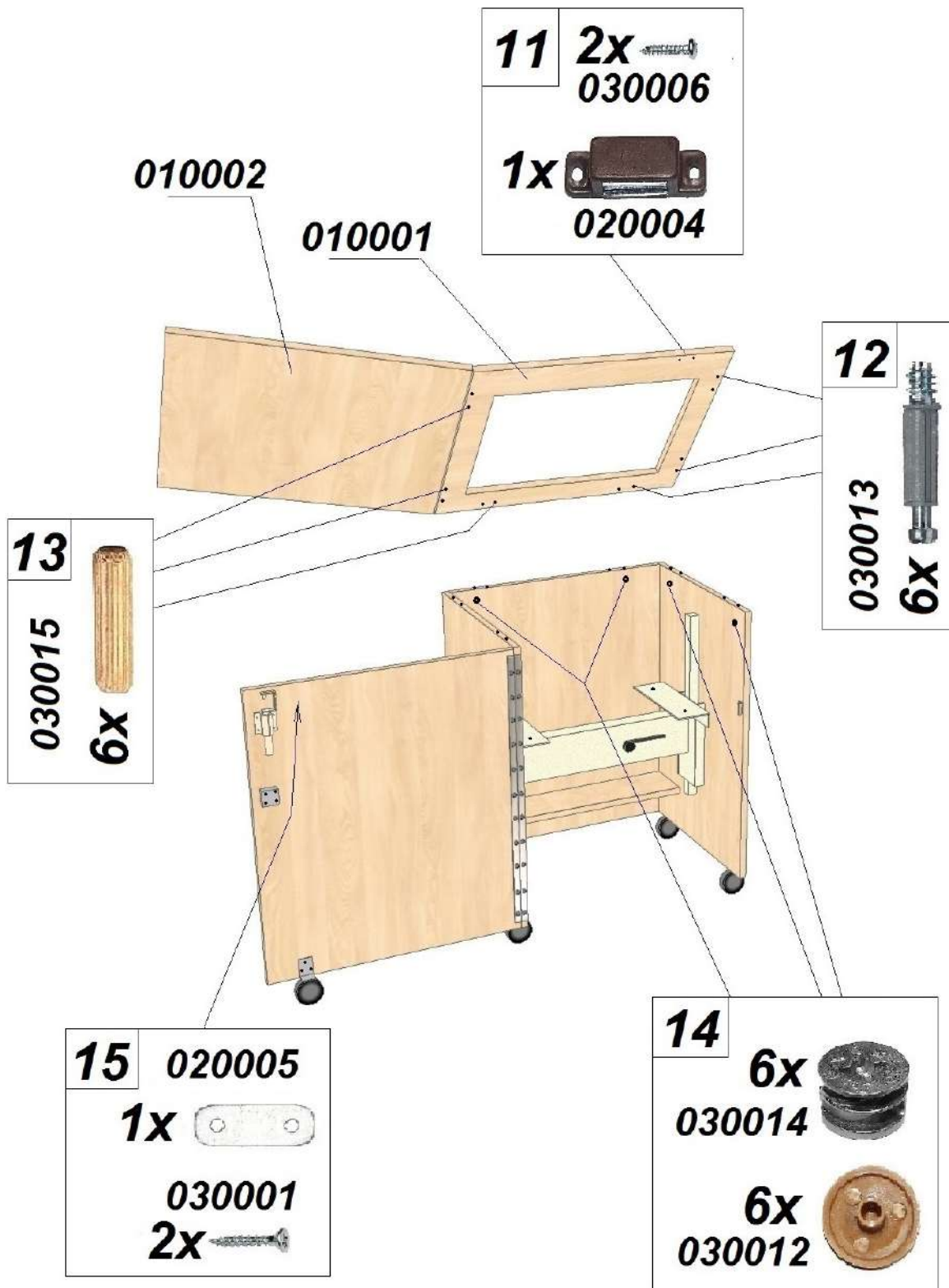

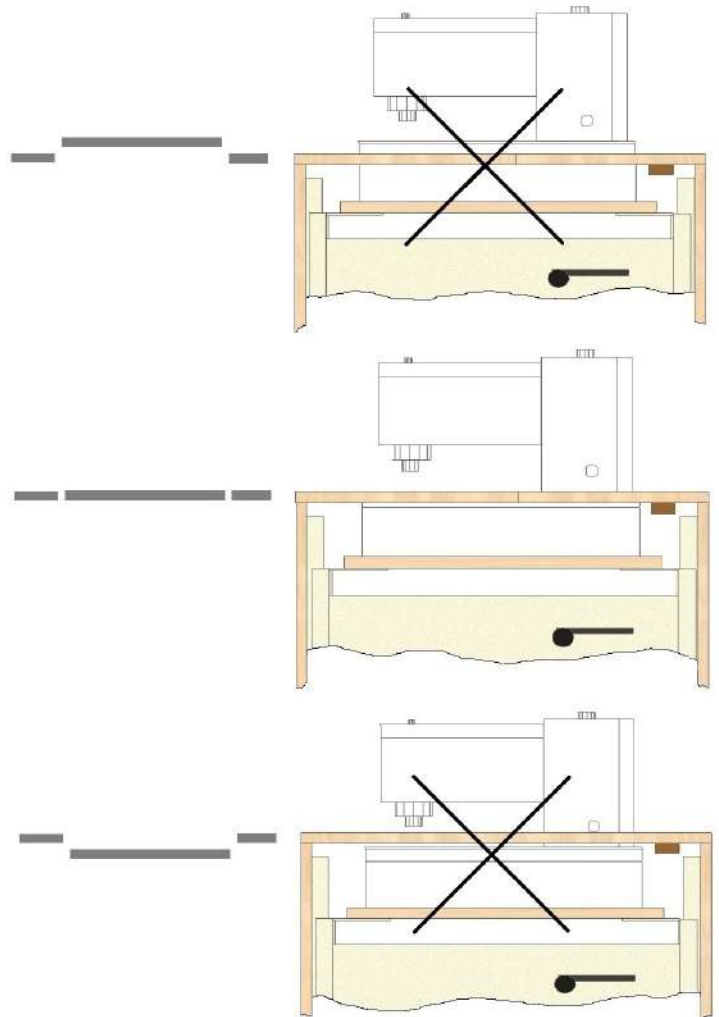
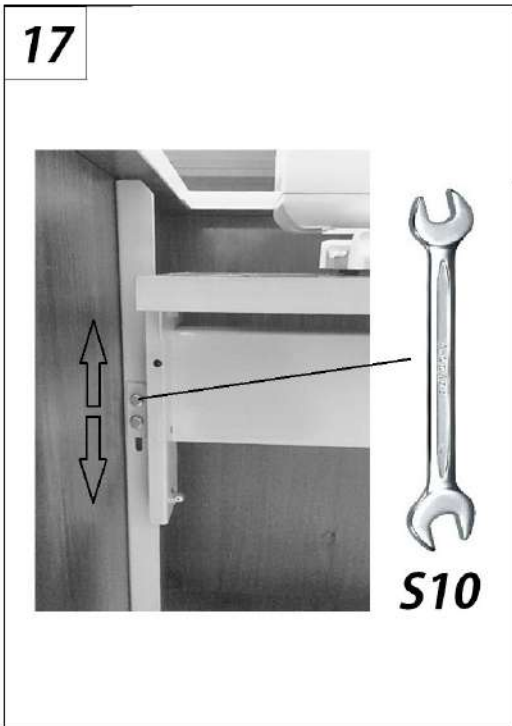
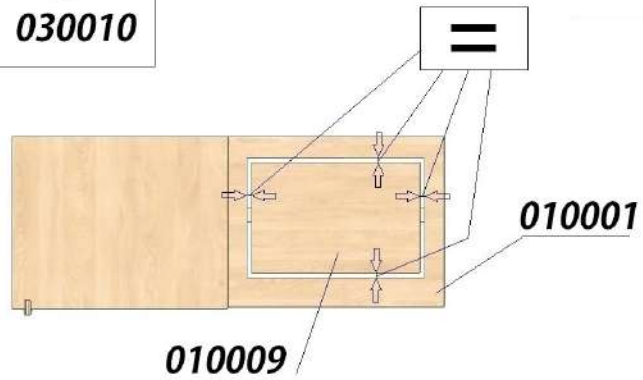
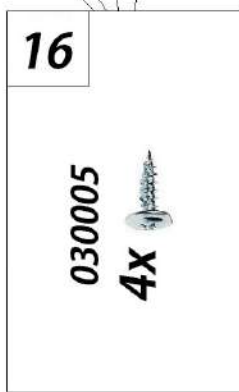
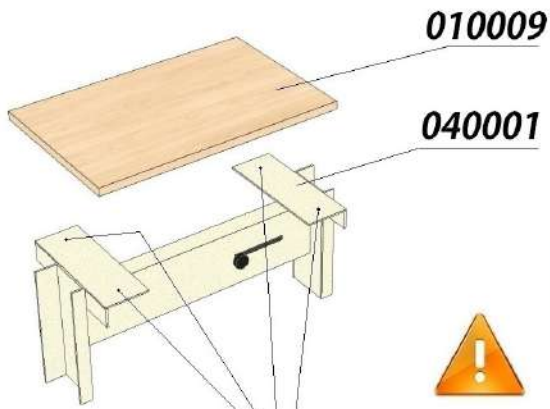

19

1 x 050003

2 x 050002

4 x 030033

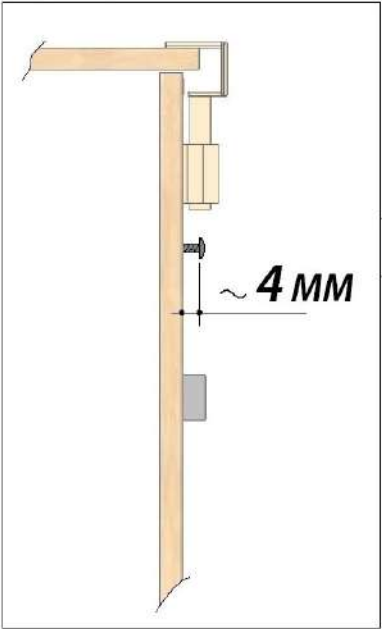

030033

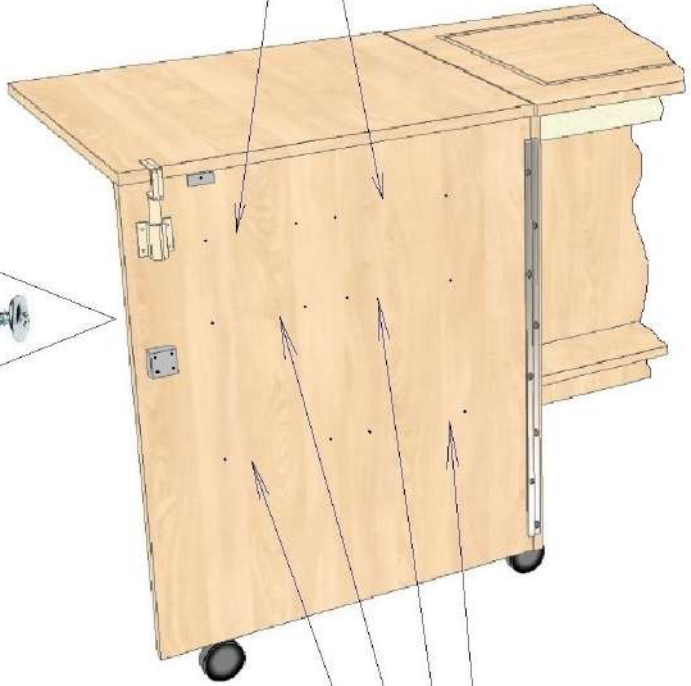

18

8 x 030033

4 x 050001

